

# Solutions in Energy Absorption and Vibration Isolation for Railway Applications



**ITT**

ENGINEERED FOR LIFE



Together, KONI and ITT Enidine will continue to expand our reach into the global railway market. ITT's global resources, green, six sigma, and lean manufacturing initiatives will allow KONI and Enidine to stay at the forefront of new technologies, research and development as well as improving production for our customers around the world.

ITT Corporation ([www.itt.com](http://www.itt.com)) is a diversified high technology engineering and manufacturing company dedicated to creating more livable environments, enabling communications and providing protection and safety. The company plays an important role in vital markets including water and fluids management, global defense and security and motion and flow control. ITT employs approximately 40,000 people serving customers in more than 50 countries. Headquartered in White Plains, NY, the company generated \$11 Billion in 2010 sales.



The KONI facility is located in Oud Beijerland, NL and the ITT Enidine facility located in Orchard Park, NY house the main operational functions of Research and Development, Engineering, Manufacturing, Finance and Controlling, Quality Assurance and Sales & Marketing for the international markets for both KONI and ITT Enidine branded products. The KONI facility in Hebron, KY provides Sales & Marketing, Engineering support, Distribution, Remanufacturing and Prototype Manufacturing capabilities to the North American customers.

The unification of the KONI and ITT Enidine experienced professionals brings the rail market a stronger concentration of product specialization and know-how to provide the best possible solution to energy absorption and vibration isolation problems.

***"KONI and ITT ENIDINE are widely regarded as the preferred source for energy absorption and vibration isolation products in the global rail market."***

As the industry leader in motion control solutions in energy absorption and vibration isolation for the rail market, KONI and ITT Enidine products include the most comprehensive line of hydraulic shock absorbers, yaw dampers, friction snubbers, air springs, custom elastomers, chevron springs, conical springs, layer springs, visco-elastic and hydraulic buffers, wire rope isolators and rate controls. We offer the highest quality at the best value for passenger rail, locomotive, freight car, track, and signal & communication applications.

KONI and Enidine offer our customers:

- ***Durability that Exceeds Standards of the Industry***
- ***Exceptional Ride Quality***
- ***Lowest Cost per Running Mile***
- ***Extended Wheel & Life Cycle Costs***
- ***Comprehensive Reconditioning Service***

If you are unsure whether one of our standard products meets your requirements, feel free to speak with one of our technical representatives:

### **ITT KONI NORTH AMERICA**

1961 A International Way  
Hebron, KY 41048  
Phone: 678.880.7005  
Fax: 859-334-3340  
Matt D'Ambrisi  
Matt.D'ambrisi@itt.com  
[www.koni-enidine-rail.com](http://www.koni-enidine-rail.com)

### **ITT ENIDINE INC.**

7 Centre Drive  
Orchard Park, New York 14127

Lou Plotnicki  
716.740.9424  
lou.plotnicki@itt.com

Jim Mohn  
716.740.9417  
james.mohn@itt.com

Dan Covelli  
716.740.9167  
dan.covelli@itt.com

Toll free: 1.800.852.8508  
Fax: 716-662-1909  
[www.koni-enidine-rail.com](http://www.koni-enidine-rail.com)

## Suspension Systems

---

### Shock Absorbers

	KONI Hydraulic Shock Absorbers .....	4, 5
	Rotary Shock Absorbers .....	6
	Friction Snubbers .....	7



### Rate Control

---

	Hydraulic Timing Device .....	8
---	-------------------------------	---

---

### Primary Springs

	Conical Springs .....	9
	Layer Springs .....	9
	Chevrons .....	9



### Secondary Springs

	Air Springs .....	10, 11
--	-------------------	--------

## Energy Absorption





---

### Heavy Duty Shock Absorbers

	Gas/Hydraulic .....	12
	Visco-elastic .....	13

## Vibration Isolation

---

	Wire Rope Isolators (WRI) .....	14
	Compact Wire Rope Isolators (CWR) .....	15
	High Energy Rope Mount Series (HERM) .....	16
	Custom Engineered Products .....	17
	Specialty Elastomers .....	18



### KONI Rail Dampers

In order to meet world class standards in both comfort and safety, the use of hydraulic shock absorbers has become an essential part of advanced rail suspension technology. To help our customers reach stringent comfort and safety requirements, KONI offers a full range of dampers that can be engineered to create the desired damping characteristic.

KONI dampers have been developed in close cooperation with our customers to optimize the damper design for each specific application. As a result, KONI offers both sealed and rebuildable damper designs.

#### Applications:

- Primary vertical dampers
- Secondary vertical dampers
- Secondary horizontal dampers
- Yaw dampers
- Inter-car dampers
- Anti-roll dampers
- Pantograph dampers
- Door actuator dampers

#### Sealed Dampers:

- 97 Series
- Max Damping Force = 15 KN
- Freely Defined Blow Off
- Symmetrical Forces
- Internal Bearing Surfaces Eliminate Metal to Metal Contact
- Robust Construction

#### Rebuildable Dampers:

- 96, 02, 04, 05 & 06 Series
- Max Force = 10, 15 & 25 KN Respectively
- Large Diameter Piston Rod
- Circulating Oil Principle
- No Metal to Metal Contact
- 25-30 Year Lifetime
- Robust Construction

For a detailed description of the various product lines, refer to our brochure "RAILWAY DAMPERS FOR ROLLING STOCK" and "DAMPER SELECTION GUIDELINES" available at [www.koni-enidine-rail.com](http://www.koni-enidine-rail.com)

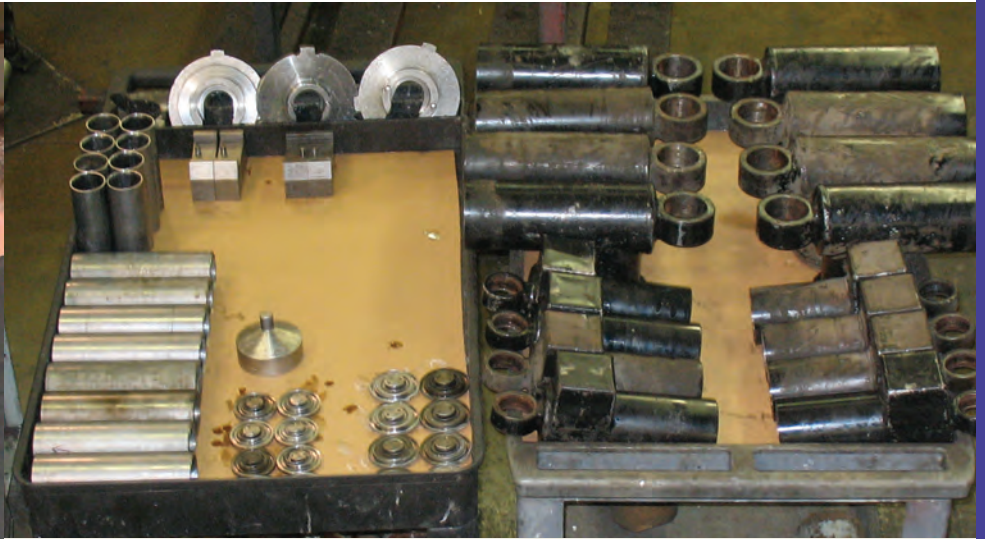

### Rebuildable Damper - Outstanding Features

- Reclaim Metal Components
- Authorized and Trained Technicians
- All Wear Components Replaced
- All Seals and Oil Replaced
- Can be rebuilt at any Authorized Overhaul Facility
- Reconditioned to Production Tolerances
- 100% Dyno Checked



# Suspension Systems

## Rotary Shock Absorbers

Overview

### Premium Suspension Damping for Rail Cars

The demand for improved ride quality and increased durability makes ITT Enidine's Rotary Shock Absorber (RSA) the perfect choice to control vertical and lateral motion in rail suspension applications. RSA's are built to outlast and outperform linear type shock absorbers, offering the best ride quality available today.

The unique RSA is a vane type shock absorber. The fluid-filled opposing chambers are interconnected through a metering valve. Rotational force applied to the end of the wingshaft displaces the fluid from the high-pressure chamber to the opposing low-pressure chamber.

This causes a resistance to relative motion and damping of the input force. The amount of damping torque is governed by angular velocity of the load applied to the shock absorber and by the valving settings.



### Outstanding Features

- Rebuildable Design allows for factory-direct reconditioning extending service life
- A Variety of Installation Arrangements solve difficult application problems
- Spring-Loaded Dynamic Shaft Seal prevents external leakage and provides continuous self-adjustment for service wear
- External Access to Fluid Reserve permits periodic check of fluid level
- Resistant to Deterioration caused by water, dirt, or corrosive action increasing dependability of operation
- Automatic "High Shock" Relief Valves protect components from damage due to instantaneous shock loads and limit torque developed in operation
- Uniform Damping Characteristics over wide temperature ranges are achieved with an automatic temperature-compensating valve
- Factory-Adjustable Valving allows changes in damping resistance to meet application requirements or to compensate for wear
- Completely Self-Contained Design

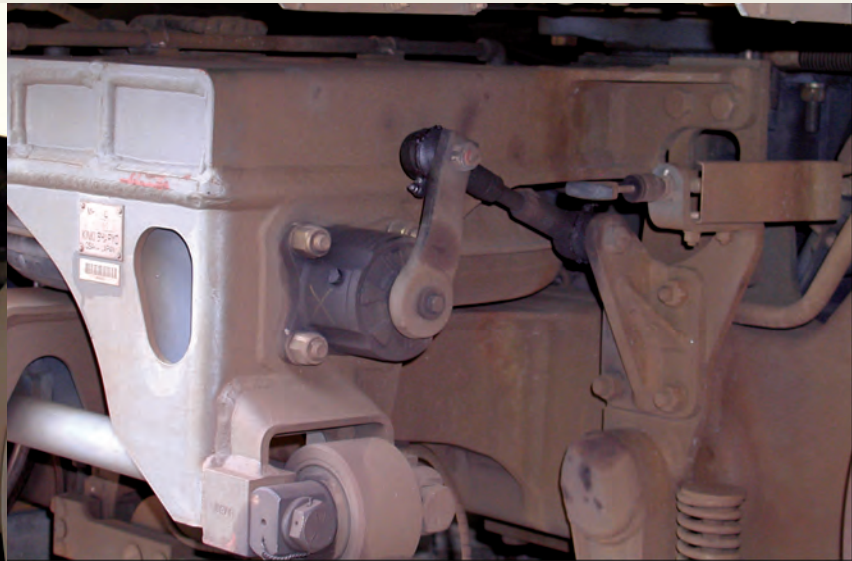

### Overview

ITT Enidine Friction Snubbers are used primarily to control vertical and lateral motion on subway passenger cars and locomotives, guarding against lading damage and providing increased ride quality. These mechanical type shock absorbers are ruggedly constructed, assuring trouble-free service under varying temperatures and environmental conditions.

### Construction and Operation

The friction snubber is comprised of a barrel containing three segmented shoes faced with specially formulated long-wearing, molded brake lining material, attached by a special bonding process. The constant pressure of a pre-compressed coil spring forces the shoes outward against the barrel. Uniform friction resistance is provided during operation through a combination of material and finish in the lining and barrel. Mountings are designed to provide "universal joint" action to accommodate any change in the angularity of the snubber caused by relative movements between the mounting members.



### Outstanding Features

- Three Segmented Shoes are forced against the barrel by spring pressure exerted equally on opposing wedge surfaces, providing consistent damping.
- Units Maintain a Constant damping force unlike hydraulic shocks which are velocity sensitive.
- Mountings Provide "Universal Joint" Action to reduce relative motion and eliminate backlash in the system.
- Self-Compensating Design for service wear. The free wedge ring allows automatic take-up as shoe lining wears.
- Wide Temperature Operating Range from -60° to 400°F.
- Standard Production Units can be provided with frictional resistance forces from 130 to 3,300 lbs.
- Vibratech Friction Snubbers can be applied to springs of any size to meet any damping requirement.

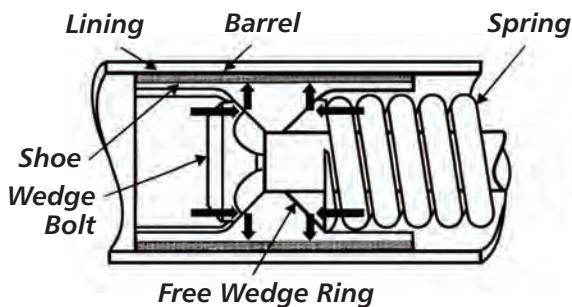

*Three segmented shoes distribute pressure uniformly.*



ITT Enidine's Hydraulic Timing Device offers an innovative alternative to conventional retarders with unmatched performance and cost advantages for both retrofit and OEM applications. After extensive development with Class I railroads and frog manufacturers, ITT Enidine's HTD answers the need for a consistently effective retarding system for slowing down the return of the wing rail on spring frogs.



### Construction and Operation

ITT Enidine's HTD features a completely sealed design that requires no oil refill, no maintenance, and longer service life. The improved seal design also eliminates environmental contamination and clean-up problems associated with oil leakage from conventional retarding systems. The lightweight HTD is designed to fit into existing retarder brackets for easy replacement or retrofit. The HTD is available as a complete kit for fast, easy installation.

### Outstanding Features

- Minimizes Wear on the wing rail and wheel flanges by keeping it open while train passes
- Extended Life of Springs and Plungers
- Rebuildable Design allows for factory-direct reconditioning for extended service life
- No Maintenance
- Permanently Sealed, requires no oil refill
- Environmentally Friendly design eliminates oil leakage, environmental contamination and clean-up costs
- Shielded Piston Rod for longer service life
- Fits Existing Retarder Brackets
- Simple to Incorporate into OEM designs





Developed in collaboration with the customers to meet specific requirements, primary suspension systems aptly tackle the complexity of wheelset guidance and bogie suspension. By assuming complete responsibility for engineering and project management, we are able to achieve economic, logistical and technical synergies.



### Conical Springs

Conical Springs permit a large variation in adjustable vertical and horizontal stiffness within a confined space. They often eliminate the need for any auxiliary damper.

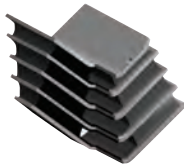
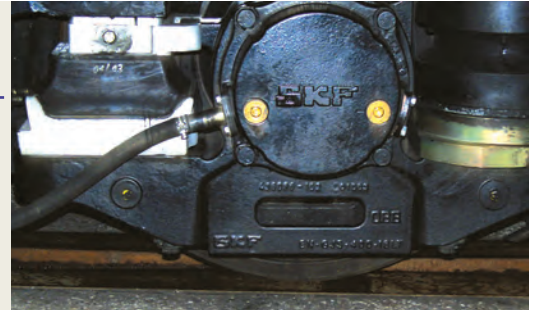

### Chevrons

Primary Chevrons are reliable spring elements in primary and secondary suspensions with decades of worldwide service in various railway vehicles. Primary chevrons are maintenance free, have a compact design and are available in a spectrum of spring designs.

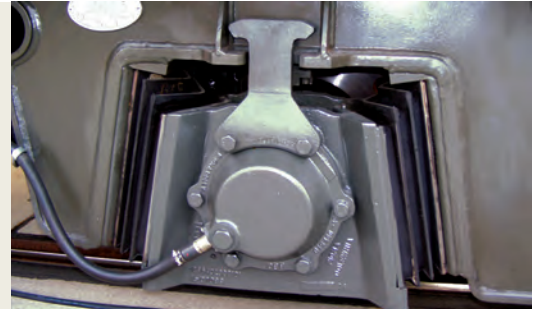

### Layer Springs

Primary Layer Springs ensure maintenance-free bearing of primary and secondary suspension systems.



### Hydraulic Springs

Consists of a conical spring and an integrated hydraulic damping system that does away with the need for a primary shock absorbers.



### Function:

Secondary Suspension Systems are located between the bogie and the car body. They are used to bear the car body and allow the bogie to rotate when the rail vehicle negotiates curves.

### Advantage:

- Increase in ride comfort thanks to pneumatic suspension irrespective of the load conditions
- Reduction in structure-borne noise transmission from the bogie to the car body
- Adjustment of the vehicle height at different loads
- Stabilization of running dynamics

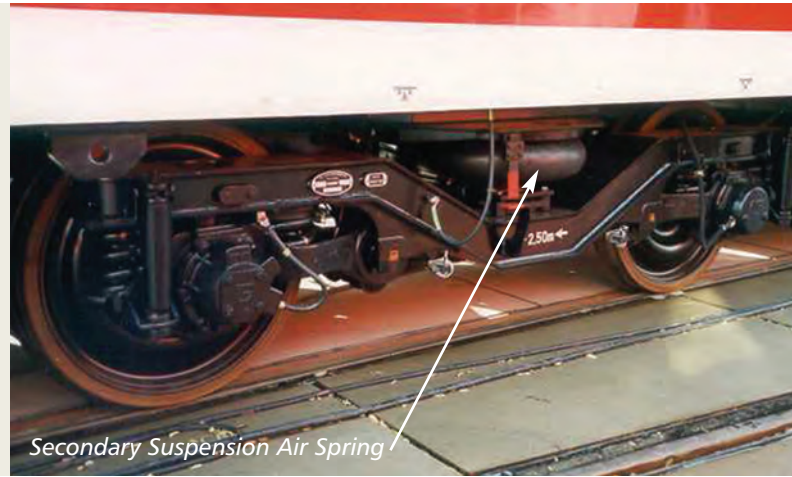

### Rolling Lobe Air Spring

Ideally suited for tram and low-floor bogies with extreme spatial limitations.

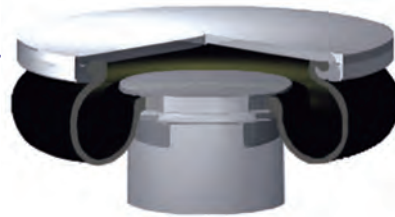

### Double Convoluted Air Springs

High-lift capability is a key feature of this spring.



### Convoluted Air Springs

Extra-high lateral deformability renders this spring ideal for bolsterless bogies as well as modern bogies used on high-speed trains and in urban and Metro systems.

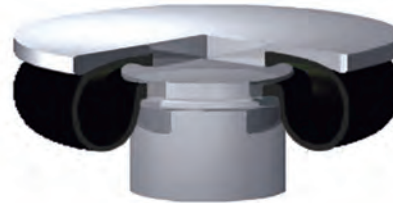

### Guided Rolling Lobe Air Spring

External guide ensures higher load-bearing capacity than with a non-guided air spring and effectively protects spring from ambient influences (vandalism); spring well suited for tram and low-floor bogies with extreme spatial limitations.



### Belted Air Spring

Higher load-bearing capacity than conventional air springs; intended mainly for bolster bogies.



### Rebuilds

A large population of Air Spring Systems can be rebuilt providing a valuable savings to the user. By utilizing the best replacement parts available, Enidine's trained technicians can recondition your worn air springs into a well functioning, cost-effective unit once again.

### Outstanding Features

- Reclaim Metal Components
- Authorized & Trained Technicians

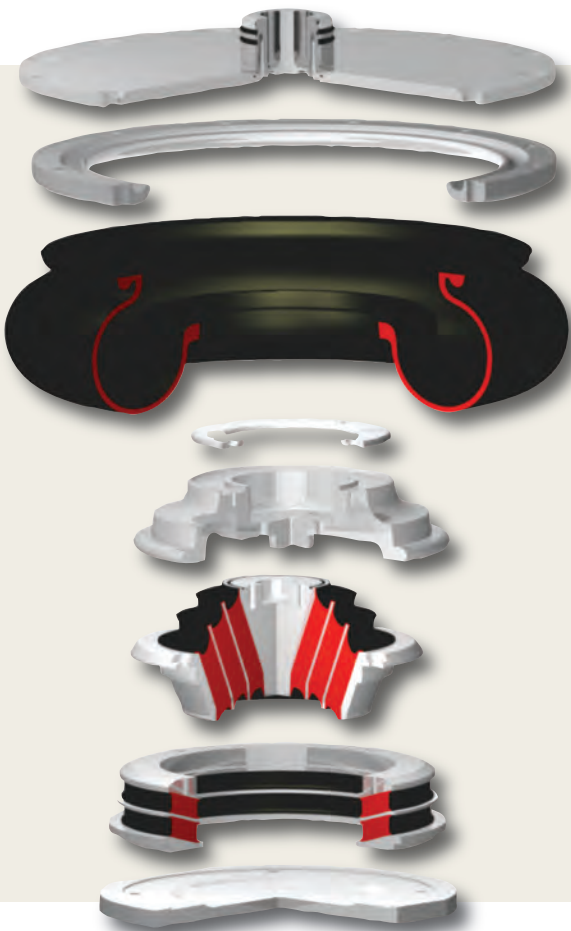

*Air Spring Rebuild on Enidine Production Floor*



ITT Enidine's Heavy Industry (HI) Series buffers safely protect heavy equipment. The large-bore, high-capacity buffers are individually designed to decelerate moving loads under various conditions and in compliance with industry mandated safety standards. Control of bridge cranes, trolley platforms, large container transfer and transportation safety stops are typical installations. Industry-proven design technologies, coupled with the experience of a globally installed product base, ensure deliverable performance that exceeds customer expectations.

The oversize bore area results in optimal energy absorption capabilities and increased internal safety factors. State-of-the-art testing facilities ensure integrity of design and product performance.

HI Series

### Features and Benefits

- Compact design smoothly and safely decelerates large energy capacity loads up to 4 million in-lbs. per cycle with standard stroke lengths.
- Engineered to meet OSHA, AISE, CMMA and other safety specifications such as DIN and FEM.
- Nitrogen-charged return system allows for soft deceleration and positive return in a maintenance-free package.
- Wide variety of optional configurations including protective bellows and safety cables.
- Available in custom-orificed non-adjustable models.
- Special epoxy painting and rod materials are available for use in highly corrosive environments.
- Surface treatment (Sea water resistant)  
Housing: gray color, three-part epoxy  
Piston Rod: hard-chrome plated steel
- Incorporating optional fluids and seal packages available to expand standard operating temperature range from (0°F to 175°F) to (-30°F to 250°F).  
(-20°C to 80°C) to (-35°C to 120°C)



The design of Jarret Shock Absorber utilizes the unique compression and shear characteristics of specially formulated silicone elastomers. These characteristics allow the energy absorption and return spring functions to be combined into a single unit without the need for an additional gas or mechanical spring stroke return mechanism.

End of track stops by Jarret are shock absorbers which can be fitted on to a steel or concrete fixed structure according to the customer's specifications. The Jarret LR Series is suited particularly well for such applications, and custom designs are also available to meet customer specific needs. Fixed track stops are generally used for impact speeds up to 10/15km/h. Buffer selection is a function of the energy to be absorbed and of the maximum impact force allowed by the train structure. For higher impact speeds, the stopping distance of the train is critical, and the use of a sliding track stop is then necessary for adequate safe deceleration. In this application the energy is absorbed and dissipated by the friction between the brake shoes and the rails.

The addition of several buffers to a standard sliding track stop adds the following advantages:

- At the moment of impact, the energy needed to initiate movement of the sliding track stop is smoothly controlled. The buffer allows the train to avoid a high peak speed which could damage the train structure.
- In the case of slower impacts only the Jarret unit absorbs the energy and the sliding does not need to be reset.

In addition to the buffer, a specific impact plate has been designed to ensure that the track stop will match correctly with the train impact zone.

### Features and Benefits

- Shock protection for all types of industries including: Defense, Automobile, Railroad, Materials Handling, Marine, Pulp/Paper, Metal Producing and Processing
- Simple design - High reliability
- High damping coefficient
- Low sensitivity to temperature variances



ITT Enidine, a preferred source for energy absorption and vibration isolation solutions, offers a full range of Wire Rope Isolators (WRI) and Elastomeric products, each designed to reduce the harmful effects of shock and vibration.

WRI's are comprised of stainless steel cable. The cable is threaded through aluminum alloy retaining bars, crimped and mounted for effective vibration isolation. With their corrosion resistant, all-metal construction, ITT Enidine WRI's are environmentally stable, high-performance shock and vibration isolators that are unaffected by temperature extremes, chemicals, oils, ozone and abrasives.

Featuring a patented crimping pattern, versatile mounting options and a variety of sizes, these helical isolator products can help ensure that your systems can effectively meet performance requirements in commercial, industrial, and defense industries, including MIL-STD-810, MIL-STD-167, MIL-S-901, MIL-E-5400, STANAG-042, BV43-44 and DEF-STND 0755.

Your systems can effectively meet the performance requirements of today's rail market by implementing these helical isolator products which feature a patented crimping pattern, versatile mounting options and a variety of sizes.

ITT Enidine's WRI products are ideally suited for a broad range of applications. Some of the common alternate materials- to improve corrosion resistance, for example, include the use of 316 SS for retainer bars, cable and hardware. Also, many different mounting options and reduced loop configurations are practical alternative options. If a standard solution is not available, ITT Enidine can custom design an isolator to suit your specifications.

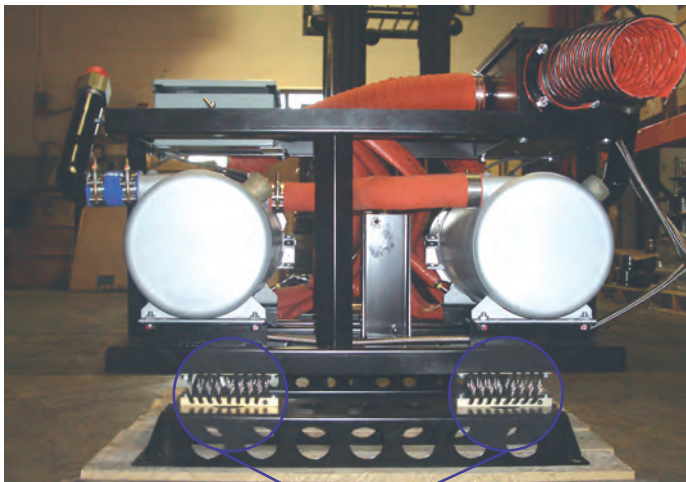
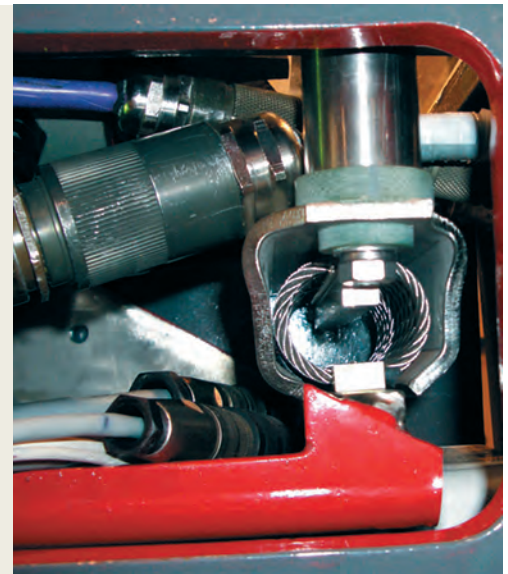

*Wire Rope Isolators*



*Wire Rope Isolators*



U.S. Patents 6,290,217  
6,244,579

For the best in vibration isolation capabilities, choose ITT Enidine's Compact Wire Rope Isolators (CWR). Smaller than traditional wire ropes, these unique isolators provide cost-effective, simultaneous shock and vibration attenuation where package space is at a premium.

ITT Enidine CWR's feature an easy, single-point installation, which allows them to be installed in virtually any application. Their small size also permits the isolation of individual system components, making them ideal for use in sensitive equipment and electronics. Just as with our standard ITT Enidine WRI's, our CWR's feature a patented, all-metal design and components that ensure maximum reliability, regardless of temperature or substrate requirement, and that can help meet MILSPECS similar to those of our Wire Rope Isolator series.

If your application is outside the standard Compact Wire Rope Isolator product range, please consult the standard Wire Rope Isolator or HERM portions of this catalog. If a standard solution is still not available, Enidine engineers can design an isolator to suit your specifications.

For further information on ITT Enidine Wire Rope, HERM and Compact Wire Rope Isolator products, technical assistance and pricing, please contact Enidine or your nearest authorized distributor. A list of ITT Enidine distributors can be found by visiting our website at [www.enidine.com](http://www.enidine.com).

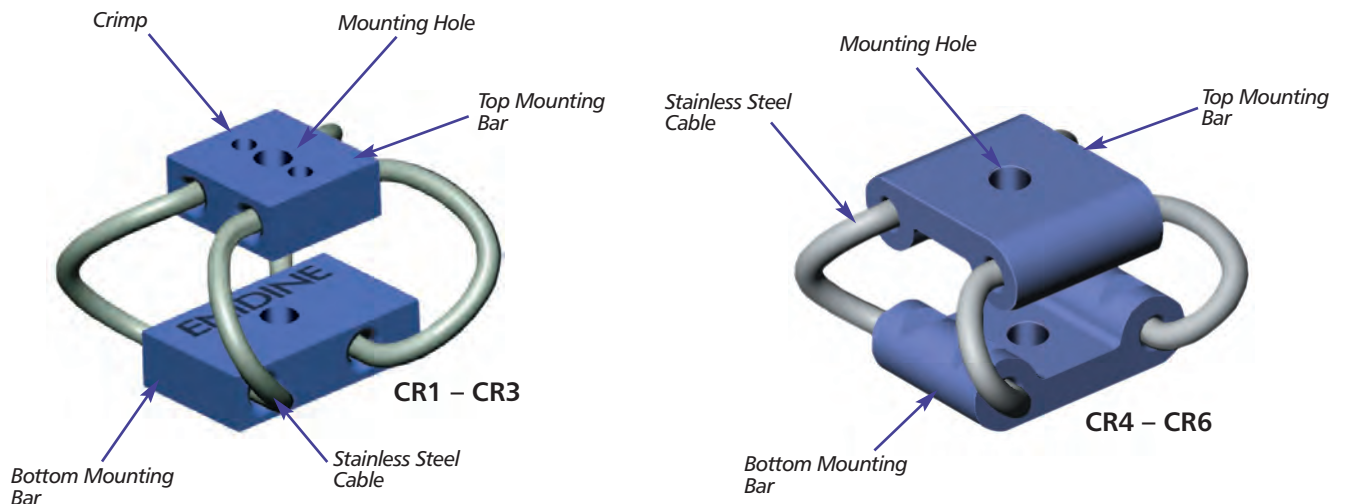



The HERM isolator incorporates the use of a traditional ITT Enidine helical wire rope isolator encased in a proprietary elastomeric compound. The stainless steel cable of the mount provides for a rugged construction, while the elastomer provides additional damping and stiffness. This unique design results in a fail safe mount with a higher stiffness and energy absorption capacity.

The mount is readily scalable and performance easily tuned by varying the wire diameter, loop size, number of loops and elastomeric properties. The HERM isolator has proven particularly strong in low natural frequency "soft deck" applications of 12-16 Hz, reducing output G's to below 15G's. Its sealed construction also provides for easy washdown. Since the mounting size of the HERM isolator is virtually identical to that of standard wire rope isolators used in many shipboard applications, equipment upgrades are both simple and seamless with drop-in replacement capability.

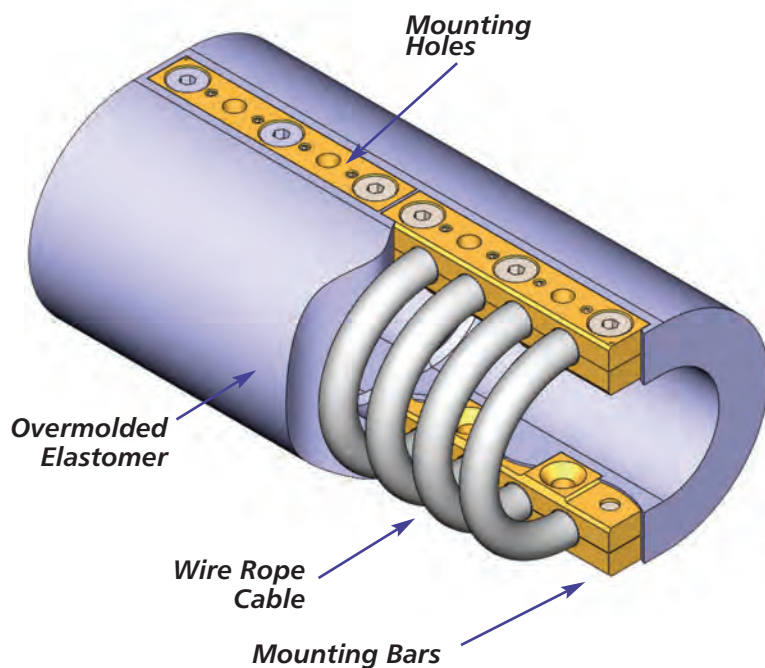

### Features and Benefits:

- Lowest profile design for a 14 Hz deck solution
- A variety of material combinations available
- Mounting identical to traditional Wire Rope Isolators
- Readily "tunable" to meet a wide range of natural frequencies
- Greater load carrying capability
- Easy retrofit on fielded equipment
- Fewer mounts required to support a given load
- Smaller "footprint" than other mounts
- Compatible with wash down requirements
- Improved noise attenuation compared to standard Wire Rope Isolators





Wire Mesh Isolators

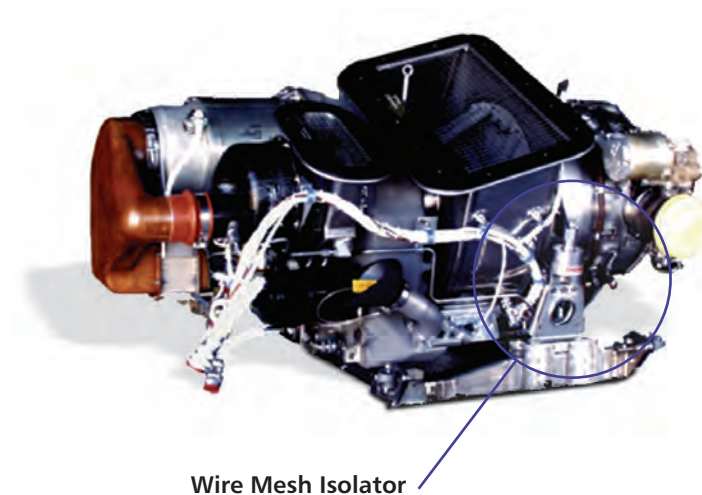

Wire Mesh Isolator

### Features:

- Wide operating temperature range
- Long service life
- Environmental compatibility
- Maintenance-free operation
- Custom sizes and shapes available

### Applications:

- Auxiliary Power Units
- Engines
- Communications Equipment
- Medical Equipment
- Sensitive Mobile Electronics

Wire mesh material can be manufactured in a multitude of shapes and sizes to accommodate your specific application. When exercised, the wire mesh damping elements convert input energy to heat. Friction is created when knitted or woven stainless steel wire strands are displaced relative to one another. Knitted metals have inherent resiliency and provide high-damping characteristics and non-linear spring rates.

### Material Development:

If your application parameters fall outside of the standard product line, you can be sure that ITT Enidine has the engineering capabilities and resources to design, test and recommend a custom solution to suit your specific needs:

- 3D Modeling
- System Analysis (Modal, Linear/Non-Linear, Dynamic Analysis and Simulation, Finite Element, Shock and Vibration)
- In-house test facility for prototypes and production models: Static Load/Deflection, Life Cycle, Vibration Frequency, Dynamic Load, Random Input and High Frequency Noise
- AS-9100 Certified
- ISO 9001 Certified



Choosing the right mount for the application is seldom as simple as ordering an off-the-shelf product. It requires not only an understanding of vibration and shock theory, but also an understanding about the available options elastomers provide: shock, vibration and noise isolation. Effective noise isolation is achieved by adding a damping material between the noise source and the surrounding environment, reducing vibration levels across the entire spectrum of input frequencies. There are two primary sources of vibration, structure-borne and air-borne, both of which can occur simultaneously and are quite common in modern industries.

The use of elastomeric isolators offers many advantages to help reduce or eliminate the harmful effects of vibration and shock in rail market applications. A variety of material choices facilitates integration into existing systems as they can bond to metals, plastics, composites and other elastomers.

As the isolator becomes integral to the supporting structure, the natural frequencies of the isolator and structure become interdependent. If the natural frequency for a given orientation is excited, it may cause a response in another orientation. For this reason, ITT Enidine uses a dynamic system analysis software package to evaluate MDOF (Multiple Degrees Of Freedom) systems for virtual evaluation of dynamic behavior.



While the advantages of elastomers are numerous, there are some limitations to their use on rail equipment. The elastomers experience temperature limitations which may restrict their use in some environments. Additionally, the chemical resistivity of certain elastomers may not be compatible with certain types of environments. Please contact ITT Enidine directly for further assistance.



Koni Shock Absorbers

Primary Springs

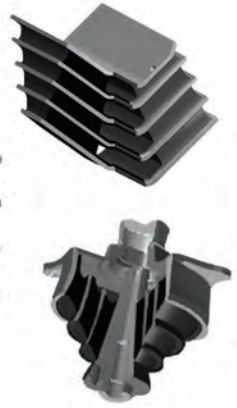

Friction Snubbers



Wire Rope Isolators



Rotary Hydraulic Shock Absorbers



Elastomers



Large-Bore Hydraulic Shock Absorbers

Compact Wire Rope Isolators



Hydraulic Timing Device (HTD)

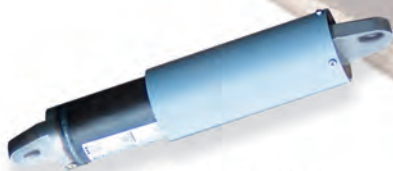

Air Springs





ENGINEERED FOR LIFE

---

**ITT KONI NORTH AMERICA**

1961 A International Way  
Hebron, KY 41048  
Phone: 678.880.7005  
Fax: 859-334-3340  
[www.enidine.com](http://www.enidine.com)

**ITT ENIDINE INC.**

7 Centre Drive  
Orchard Park, New York 14127  
Toll free: 1.800.852.8508  
Fax: 716-662-1909  
[www.enidine.com](http://www.enidine.com)